

TCX50 Standard Tire Changer

Conventional tire changer



Key features of the TCX50 Tire Changer

Heavyweight

- ✓ Heaviest model in its class
- ✓ Long service life

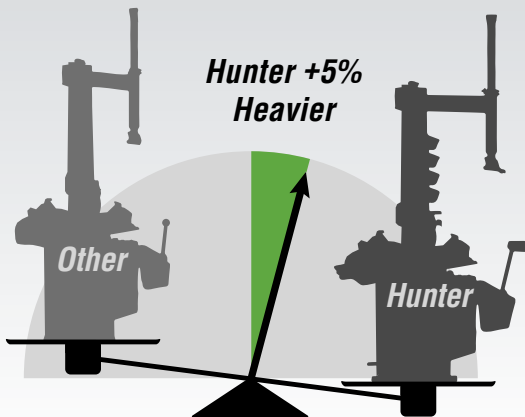

Class-Leading Rigidity

- ✓ Rigid chassis reduces damage risk and operator effort

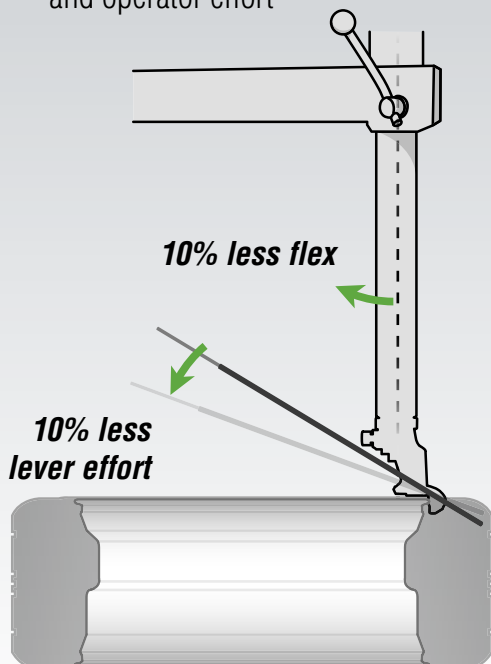

TCX50E shown

Easy-to-Use Adjustable Tabletop

- ✓ Built-in adjustment system provides 10- to 26-in. clamping range
- ✓ All jaws adjust simultaneously for mistake-free clamping
- ✓ Polished tabletop for easy cleanup
- ✓ Hi-grip jaw covers add mounting torque and protect wheels
- ✓ Diameter marks aid external clamping

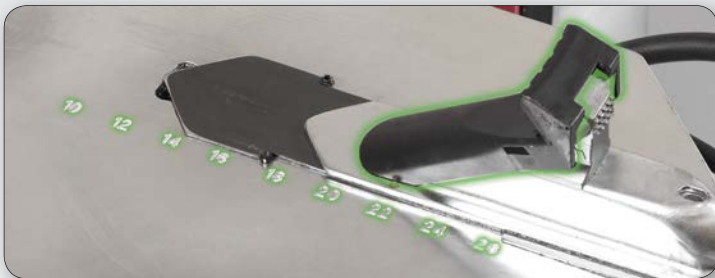

More Torque, More Speed

More Torque

- ✓ Unique 110V or 220V* motor generates more torque than popular air or electric models.

*110V  or 220V  configured at installation.

**Hunter +20%
More Torque**

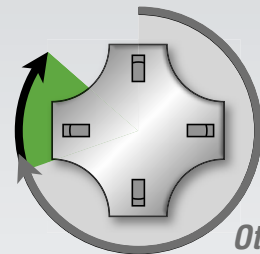

Others

Faster

- ✓ Faster than popular alternatives — increases productivity
- ✓ Electric tabletop doesn't slow down under load like air motors

**Hunter
+15%
Faster**

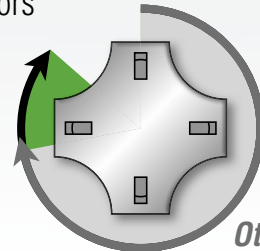

Others

PowerOut™ Bead Loosener

- ✓ Most powerful bead breaker in its class
- ✓ Fingertip control eases service of large assemblies
- ✓ Three-way adjustable for best rim fit
- ✓ Shovel protectors standard

**Hunter +5%
More Force**

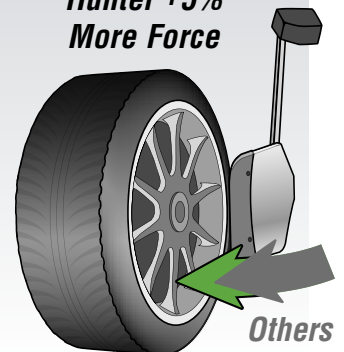

Others

Popular accessories



Bead Press Arm - 20-2833-1
(Standard on TCX51)

Aids mounting, demounting and clamping. Hook lifts heavy tires



Bead Press System - 20-2834-1
(Standard on TCX53)

Aids mounting and demounting with tremendous power and control



Blast inflator - RP11-8-11100403

Direct bursts of compressed air to seat difficult beads

Specifications

Electrical requirements

110 mode	110V, 1 ph, NEMA 5-15P
220 mode	220V, 1 ph, NEMA L6-20P
Air pressure operating range	110–145 psi
Air volume of inflation tank	4.75 gallons
Wheel Clamping (nominal)	
External (min-max)	10 in. – 26 in.
Internal (min-max)	12 in. – 28 in.
Table rotation speed	
Electronic motor	10 CW / 10 CCW
Air motor	10 CW / 5 CCW
Maximum tire diameter	46 in.
Maximum tire width	14 in.
Bead loosener width	16 in.
Noise level	74 dB
Machine weight	630 lbs.

Some dimensions, capacities and specifications may vary depending on tire and wheel configurations.

Because of continuing technological advancements, specifications, models and options are subject to change without notice.

Models

TCX50E	Electric motor
TCX50A	Air motor

Standard equipment

- ✓ Polymer mount head
- ✓ Standard bead lever
- ✓ Bead lever protectors (polymer)
- ✓ Shovel protectors (polymer)
- ✓ Hi-grip jaw protectors (polymer)
- ✓ Inflation system
- ✓ Two storage pockets

Optional equipment

20-2833-1	Bead press arm upgrade
20-2834-1	Bead press system upgrade
20-2045-1	Wheel lift
20-2885-1	Storage shelf
RP11-8-11100403	Blast inflator



0116GAP3M.36

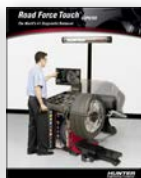

Be sure to check out other Hunter literature for more quality products from Hunter Engineering.

HUNTER
Engineering Company

www.hunter.com